

**50**  
1968-2018  
YEARS/ANOS

# CATÁLOGO BASORFIL 2023

CENTROS DE  
DATOS

SECTOR

**ALIMENTARIO**

INFRAESTRUCTURAS

**TERCIARIAS**

ENERGÍAS

**RENOVABLES**

EDIFICIOS

**CORPORATIVOS**



**3E Basor**  
CABLE TRAY SPECIALIST

**BANDEJAS**  
*enchufables*  
de **REJILLA**  
para uso  
**GENERAL**

## BF2R H65



BF2R-2F 60x65



BF2R

	B		H			EZ1000	I304
	mm	inch	mm	inch		REF	REF
BF2R-2F 60X65	60	2"	65	2"	0	217354	207516
BF2R 100X65	100	4"	65	2"	0	217355	207502
BF2R 150X65	150	6"	65	2"	0	217356	207503
BF2R 200X65	200	8"	65	2"	1	217357	207504
BF2R 300X65	300	12"	65	2"	1	217358	207505
BF2R 400X65	400	16"	65	2"	1	217359	207506
BF2R 500X65	500	20"	65	2"	1	217361	207507
BF2R 600X65	600	24"	65	2"	2	217362	207508



L = 3 m (10 ft)

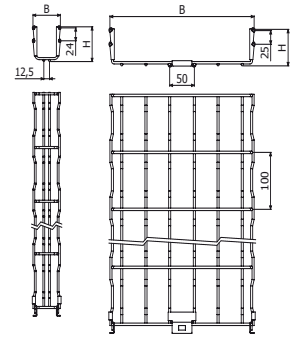

BF2R-2F  
60x65

BF2R  
H65

## BF2R H105



L = 3 m (10 ft)

	B		H			EZ1000	I304
	mm	inch	mm	inch		REF	REF
BF2R 100X105	100	4"	105	4"	0	217363	218559
BF2R 150X105	150	6"	105	4"	0	217364	218560
BF2R 200X105	200	8"	105	4"	1	217365	207509
BF2R 300X105	300	12"	105	4"	1	217366	207510
BF2R 400X105	400	16"	105	4"	1	217367	207511
BF2R 500X105	500	20"	105	4"	1	217369	207512
BF2R 600X105	600	24"	105	4"	2	217370	207513

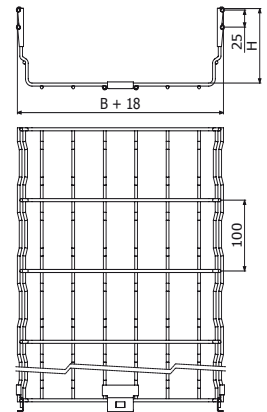

## TBF (H65) TEBF (H105)

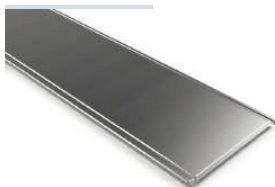

TBF (BF2R H65)	B		GS	I304	TEBF (BF2R H105)	B		GS	I304
	mm	inch	REF	REF		mm	inch	REF	REF
TBF 60	60	2"	800001	800016	TEBFR 100	100	4"	800009	800024
TBF 100	100	4"	800002	800017	TEBFR 150	150	6"	800010	800025
TBF 150	150	6"	800003	800018	TEBFR 200	200	8"	800011	800026
TBF 200	200	8"	800004	800019	TEBFR 300	300	12"	800012	800027
TBF 300	300	12"	800005	800020	TEBFR 400	400	16"	800013	800028
TBF 400	400	16"	800006	800021	TEBFR 500	500	20"	800014	800029
TBF 500	500	20"	800007	800022	TEBFR 600	600	24"	800015	800030
TBF 600	600	24"	800008	800023					



L = 1.5 m

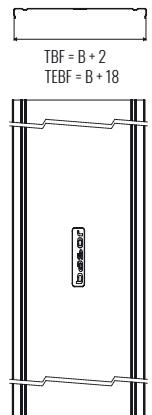

TBF = B + 2  
TEBF = B + 18

## BFR H65 - HDG



BFR-2F 60x65



BFR 100-600x65

	B		H		GC
	mm	inch	mm	inch	REF
BFR-2F 60X65	60	2"	61	2"	215576
BFR 100X65	100	4"	65	2"	200291
BFR 150X65	150	6"	65	2"	200292
BFR 200X65	200	8"	65	2"	200293
BFR 300X65	300	12"	65	2"	200294
BFR 400X65	400	16"	65	2"	200295
BFR 500X65	500	20"	65	2"	200296
BFR 600X65	600	24"	65	2"	200297

$B \leq 200$  2x CGBF (204360)

$B \geq 300$  3x CGBF (204360)

L = 3 m (10 ft)

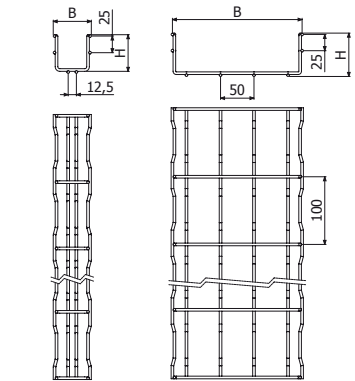

BFR-2F 60x65

BFR H65



## EBFR H105 - HDG



L = 3 m (10 ft)



**BasorFIL Energy**

	B		H		GC
	mm	inch	mm	inch	REF
EBFR 100x105	100	4"	105	4"	207918
EBFR 150x105	150	6"	105	4"	207919
EBFR 200x105	200	8"	105	4"	207333
EBFR 300x105	300	12"	105	4"	207334
EBFR 400x105	400	16"	105	4"	207335
EBFR 500x105	500	20"	105	4"	207336
EBFR 600x105	600	24"	105	4"	207337

$B \leq 200$  2x CGBF (204360)

$B \geq 300$  3x CGBF (204360)

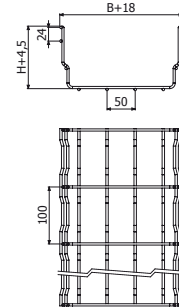

## TBF (H65) TEBF (H105)

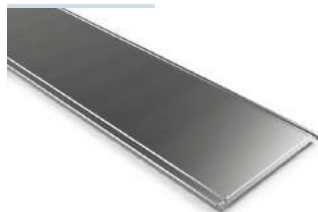

TBF (BF2R H65)	B		GC	TEBF (BF2R H105)	B		GC
	mm	inch	REF		mm	inch	REF
TBF 60	100	2"	800031	TEBFR 100	100	4"	800039
TERE 100	150	4"	800032	TEBFR 150	150	6"	800040
TERE 150	200	6"	800033	TEBFR 200	200	8"	800041
TERE 200	300	8"	800034	TEBFR 300	300	12"	800042
TERE 300	400	12"	800035	TEBFR 400	400	16"	800043
TERE 400	500	16"	800036	TEBFR 500	500	20"	800044
TERE 500	600	24"	800037	TEBFR 600	600	24"	800045
TERE 600	600	24"	800038				

L = 1.5 m

L = 1.5 m

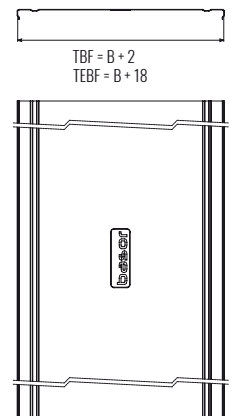

## CULA



	Pap	EZ	GC	i304
	N-m	REF	REF	REF

CULA 65/105

10

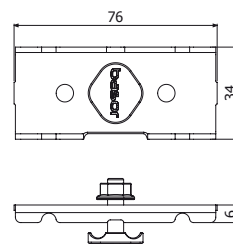

## CGBF



	Pap	EZ	GC	i304
	N-m	REF	REF	REF

CGBF

10

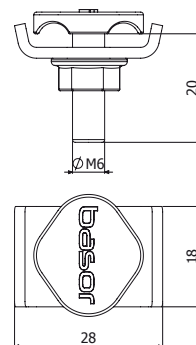
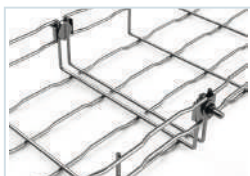

## CTBF



	Pap	EZ	GC	i304
	N-m	REF	REF	REF

CTBF

10

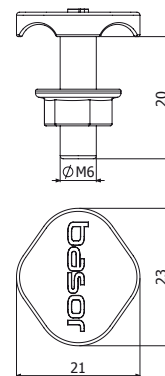

## UCBF



	Pap	EZ	GC	i304
	N-m	REF	REF	REF

UCBF

10

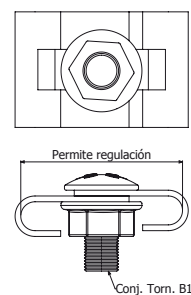
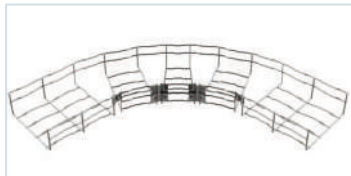

## MU



	L	GS	i304
	mm	REF	REF
MU 500	500	200357	209872
MU 275	275	210007	☎

 2 x CTBF

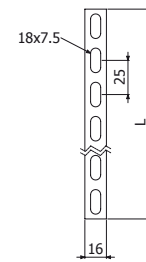
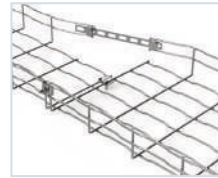

## KIT90



	GS
	REF
KIT90	218641

 2 x (ULA 65 EZ + ISO7380-2 M6x25 EZ + DIN6923 M6 EZ)

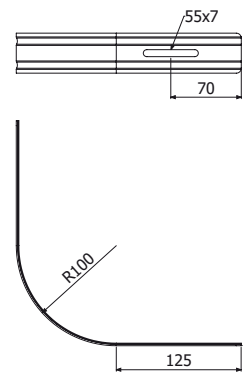
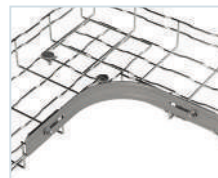

## SL



	GS	GC	i304
	REF	REF	REF
SL	200355	200365	200375

 BFR/BF2R 60x65 - 100x65

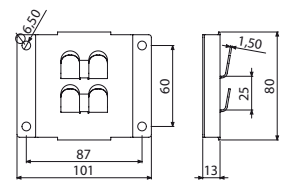

## SLS



	GS	GC	i304
	REF	REF	REF
SLS	200360	200370	200380

 BFR/BF2R 60x65 - 100x65

 VR6/VR8 - BFR/BF2R 60x65..200x65

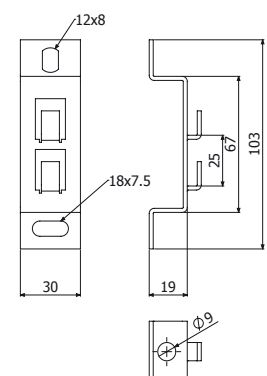

## SPVBF



	H		A		e	GS	i304
	mm	inch	mm	inch	mm	REF	REF
SPVBF 100/70	100	4	70	3	1,5	218716	218717
SPVBF 100/120	100	4	120	5	1,5	218705	218706

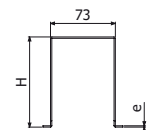
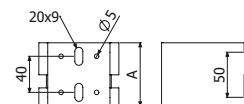
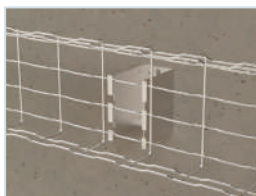

SPVBF 100/70

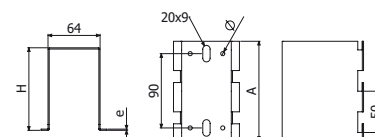

SPVBF 100/120

## SSC



	D	EZ	GC	i304
	mm	REF	REF	REF
SSC 6	7	218761	218760	-
SSC 8/10	10,5	202064	200363	200373



SSC 6 -> M6  
SSC 8/10 -> M8/M10



60x35, 150x35, 60x65.

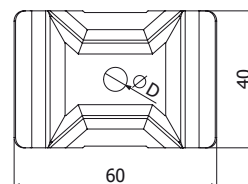
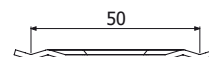

## SST



	GS	i304
	REF	REF
SST	205724	218803

VR8/VR10

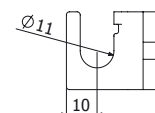
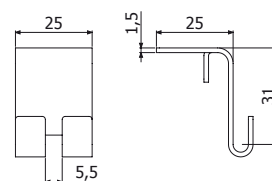

## CFBFR41



	i301
	REF
CFBFR41	210284



SP, SP3S, 41/82

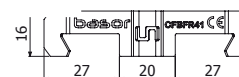
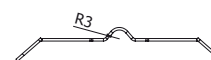

## STB2



STB2 12-32



GS	GC	i304
REF	REF	REF
218798	218799	218800

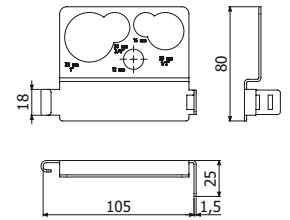

## STBU



STBU

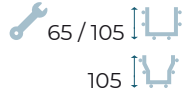

GS
REF
205834

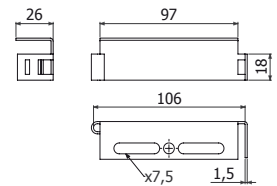

## SUC

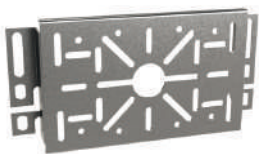

SUC



29-70 mm



79x50, 98-128x50, 15-55x82

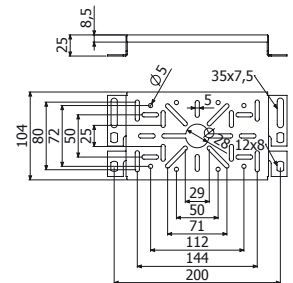
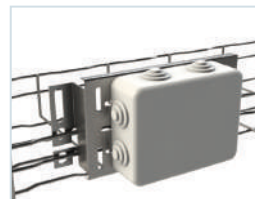

L: 30 -147

## SUCM



SUCM



L: 30 -48

GS	GC	i304
REF	REF	REF
200359	200369	200379

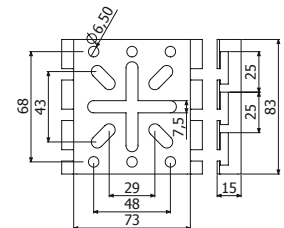

## BJC



BJC



GS	GC
REF	REF
206451	206452

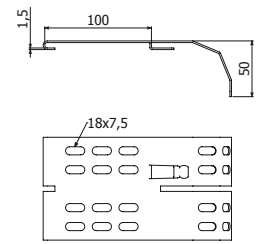

## BJCM



BJCM



GS
REF
209807

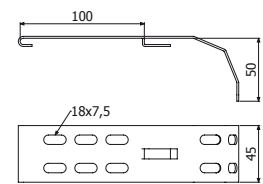

## SFL



SFL



GS	i304
REF	REF
205906	211308

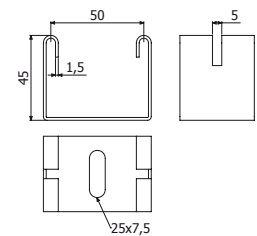
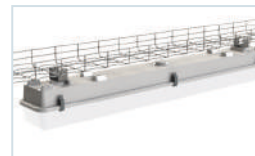

## PTBFR



PTBFR



4 x PTBFR => 1 x TERE (BF2R/BFR)

GS	i304
REF	REF
210253	210254

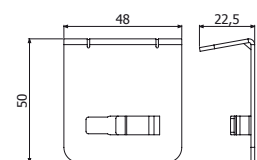
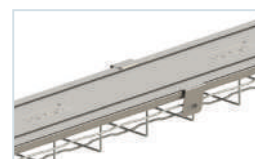

H65-105-150



## SCBFR



SCBFR

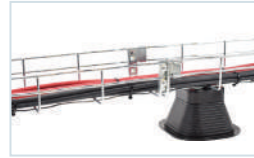

GS
REF
223328

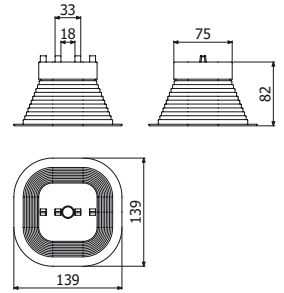

## PBF



PBF

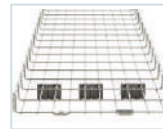
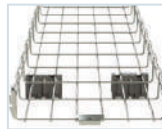

	e		CTA		GS	GC	i304
	mm	kg	lb		REF	REF	REF
PBF	1	250	551		205590	204397	208777

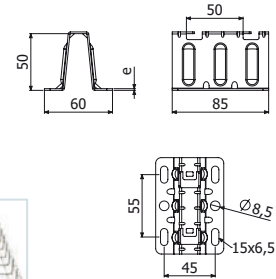

## SV



SV



CTBF (204362-EZ / 207132-GC)

	B		GS	GC
	mm	inch	REF	REF
SV 100	100	4"	500169	500227
SV 150	150	6"	500170	500228
SV 200	200	8"	500171	500229
SV 300	300	12"	500173	500231
SV 400	400	16"	500236	500232
SV 500	500	20"	500238	500234
SV 600	600	24"	500239	500235

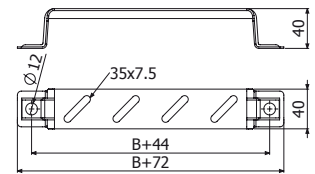

## SMP



SMP



	e	SWL	B		GS	GC
	mm	kg	mm	inch	REF	REF
SMP 100	1,5	164	100	4"	500200	500209
SMP 150	1,5	133	150	6"	500201	500210
SMP 200	1,5	102	200	8"	500202	500211
SMP 300	2	90	300	12"	500204	500213
SMP 400	2	82	400	16"	500205	500214
SMP 500	2	73	500	20"	500207	500216
SMP 600	2	65	600	24"	500208	500217

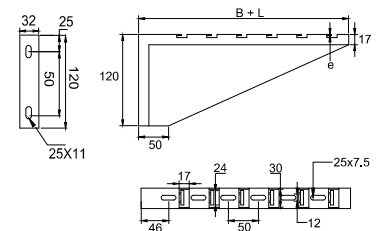

## C-SHO



C-SHO



PSHO

	B		e	SWL		GS	GC	e	SWL		i304
	mm	inch		kg	lb	REF	REF		mm	kg	lb
C-SHO100	100	4"	1,5	105	231	207230	207239	1,5	85	187	207490
C-SHO150	150	6"	2	100	220	207231	207240	1,5	69	152	207491
C-SHO200	200	8"	2	81	178	207232	207241	1,5	45	99	207492
C-SHO300	300	12"	2	45	99	207233	207242	1,5	35	77	207493
C-SHO400	400	16"	2	27	59	207234	207243	1,5	22	48	207494
PSHO	-	-	2	-	-	206240	206318	2	-	-	218139

TFSO(200894)

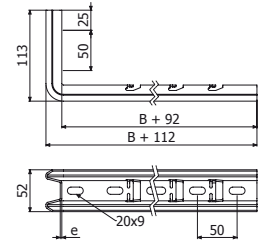

C-SHO



TFSO

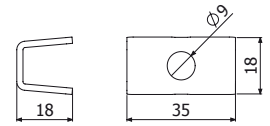

PSHO

## C-SVO



	L		e	GS	GC
	mm	mm		REF	REF
C-SVO	2400	1,5	16	500260	500273
C-SVO	3000	1,5	16	500261	500274
C-SVO	2400	2	14	500262	500275
C-SVO	3000	2	14	500263	500276

	L		e	GS	GC
	mm	mm		REF	REF
C-SVO 100	250	1,5	16	500264	500277
C-SVO 150	300	1,5	16	500265	500278
C-SVO 200	350	1,5	16	500266	500279
C-SVO 300	450	1,5	16	500268	500281
C-SVO 400	550	2	14	500269	500282
C-SVO 500	650	2	14	500271	500284
C-SVO 600	750	2	14	500272	500285

TFSO (200894)

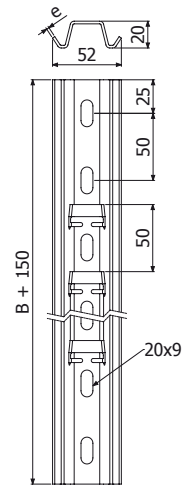

TFSO

## SP3S + SPM P41



SP3S

	L	e	ep	EZ	GC
	mm	mm	mm	REF	REF
SP3S 400	400	2	6	500180	500186
SP3S 500	500	2	6	500181	500187
SP3S 600	600	2	6	500182	500188
SP3S 800	800	2	6	500183	500189
SP3S 1000	1000	2	6	500184	500190
SP3S 1200	1200	2	6	500185	500191

TF41 PVC ( 205627)

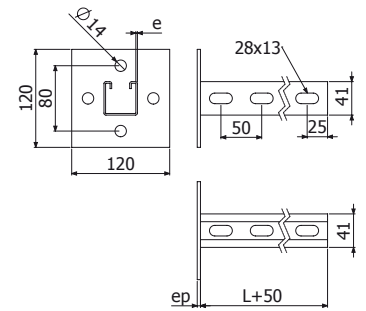

SPM P41

	e	SWL	L	GS
	mm	kg	mm	inch
SMP P41 100	1,5	155	100	4"
SMP P41 150	1,5	147	150	6"
SMP P41 200	1,5	140	200	8"
SMP P41 300	2	160	300	12"
SMP P41 400	2	146	400	16"
SMP P41 500	2	128	500	20"
SMP P41 600	2	110	600	24"

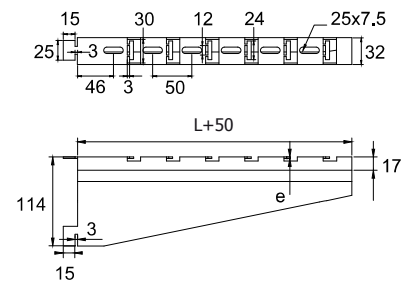

CLICK



SP3S + SPM P41

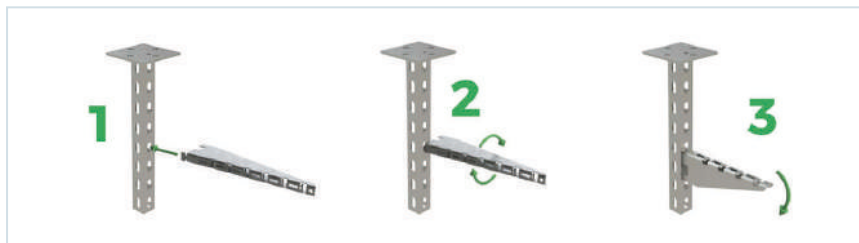

TF41

## TTL



TTL

	Smin	Smax	Dcable	A	LTN
	mm <sup>2</sup>	mm <sup>2</sup>	mm	mm	REF
TTL 10-35	10	35	4 a 8	25	208189

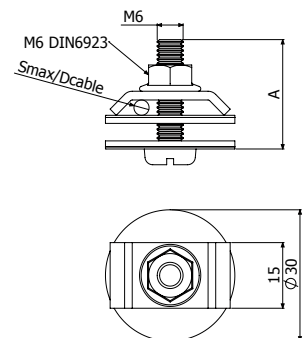

Basor Peru S.A.C.  
Venancio Ávila 1988  
Cercado de Lima  
Lima 15083 - Perú  
Tel.: +51 1 502 3329  
Email: peru@basor.com